

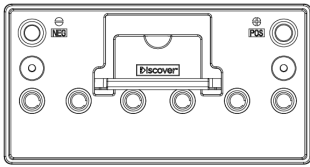

Discover® DRY CELL Traction Industrial batteries outperform traditional Flooded, AGM, and Gel deep-cycle batteries in demanding traction and industrial applications. The batteries are designed to deliver a long runtime, high operating current and withstand deep discharge and are ideal for powering equipment that is used multiple times a day.

DRY CELL Traction Industrial batteries have been used and trusted for more than ten years by the world's largest industrial Original Equipment Manufacturers. Specific charge algorithms are available that support optimal battery performance and longevity.

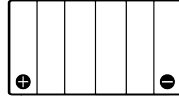
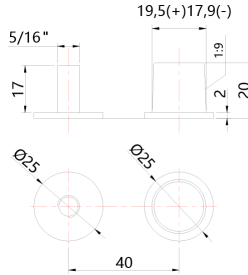
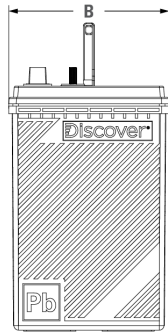
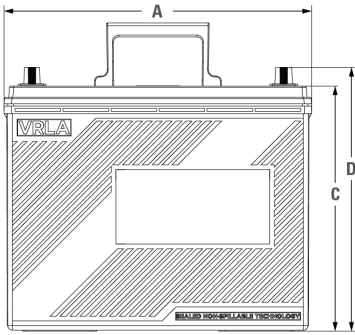

MECHANICAL SPECIFICATIONS

Industry Reference	BCI: 31T	
Length A (in/mm)	13	330
Width B (in/mm)	6.8	172
Height C (in/mm)	10.4	263
Total Height D (in/mm)	11.1	283
Weight (lbs/kgs)	86.9	39.5
Terminal *	AM	
Technology	DRY CELL AGM, VRLA	

NOTE 1: Dimensions have a ±2 mm (0.08 in) tolerance. Weights may vary.
NOTE 2: Refer to [terminal guide](#) on website for torque values.

PERFORMANCE SPECIFICATIONS

Amp Hours (AH)			Minutes of Discharge				
3 HR	5 HR	20 HR	@25A	@56A	@75A	@85A	@100A
110	125	145	310	120	80	66	55

3 HR: 1.70VPC; 5 HR: 1.75VPC; 20 HR: 1.80VPC. All at 25°C/77°F

ELECTRICAL SPECIFICATIONS

Voltage (V)	12
Internal Resistance (m?)	4
Short Circuit (A) (20°C / 68°F)	3800
Self-Discharge (20°C / 68°F)	2-3% per month
Charge Temperature	Min: -10°C (14°F) Max: 50°C (122°F)
Discharge Temperature	Min: -40°C (-40°F) Max: 50°C (122°F)
Storage Temperature	Min: -20°C (-4°F) Max: 60°C (140°F)

NOTE 3: Extra considerations must be given when designing systems for use at maximum temperatures.
NOTE 4: Internal Resistance is approximate.

FEATURES

HYDRO POLYMER

- Organic capillary separators with hydro polymer electrolytes resist dry-out and prevent thermal runaway
- Maintains performance characteristics over operational life

ENHANCED ALLOYS

- Thick plates with graphite enhanced alloys deliver maximum runtime over operational life

CARBON BOOST

- Carbon additives to increase duty cycle performance, charge acceptance and partial state of charge operation

AUTOMATED THROUGH-THE-PARTITION WELD

- Improved intercell weld consistency, and less lead waste than manual welding process (key models)
- Supports higher current loads and lowers internal resistance

POLYPROPYLENE CASE

- High heat resistance and durability (key industry models)
- High precision pressure relief valves reduce water loss and extend life
- Integrated flame arrestors prevent fire and explosion

BENEFITS

ENHANCED RUNTIME

- High amp hour capacity
- High operational voltage over lifetime
- Delivers 80% DoD above 1.9 VPC

EXTENDED SERVICE LIFE

- Long life superior to deep-cycle FLA / AGM / Gel batteries
- 550+ cycles 70% DoD (IEC 254-1 Traction Lead-Acid)
- 350+ cycles 100% DoD (DIN 43 539 VRLA)

RESILIENCE

- Partial stage of charge operation superior to AGM
- Intense duty cycling superior to AGM / Gel
- Overcharge and over-discharge resilience superior to AGM
- Compatible with AGM / Gel semi-traction charge profile

EXTREME TEMPERATURES

- High temperature life superior to AGM
- Low temperature operation superior to FLA / AGM / Gel batteries

EXTREME VIBRATION RESISTANCE

- Vibration resistance superior to AGM / Gel
- Shock tested (IEC 61373, DIN EN 61373, SAE J537)

OEM TRUSTED

- Exceeds OEM specifications
- Innovative technology
- Global service and support

RELIABLE AND SAFE

- Valve Regulated Lead-Acid, Dry Cell AGM
- Maintenance-free, nonspillable, no-gassing
- Spark and explosion tested (SAE J1495)

CERTIFIED QUALITY

Discover® manufacturing facilities are fully certified to ISO 9001/14001 and OSHA 18001 standards.

Designed in accordance with and published in compliance with applicable standards, including:

- IEC 60254-1. Lead-Acid Traction
- DIN 43 539. VRLA
- SAE J537. Storage
- UL, CE Health Safety Certified

SHIPPING CLASSIFICATION

- Classified as a nonspillable battery
- Without restriction for transport by Sea (IMDG amendment 27)
- Without restriction for transport by Air (IATA/ICAO provision 67)
- Without restriction for transport by Ground (STB, DOT-CFR-HMR49)



Temperature Effects on Capacity

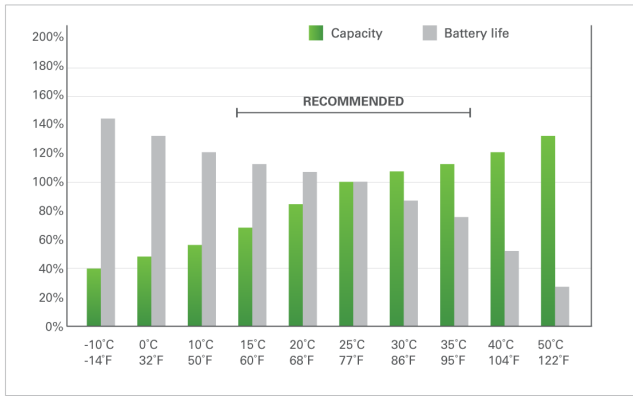

Test Standards and Cycle Life

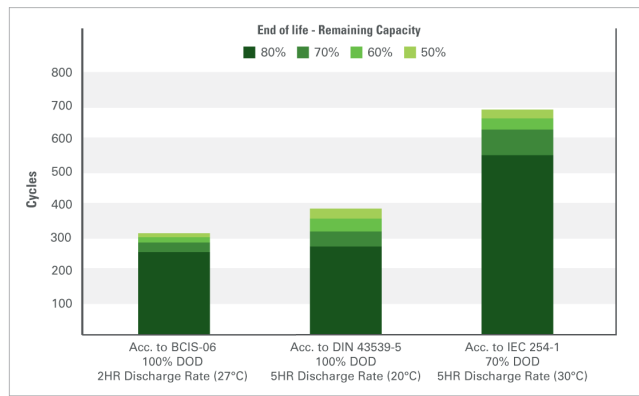

Open Circuit Voltage in Relations to SOC (20°C)

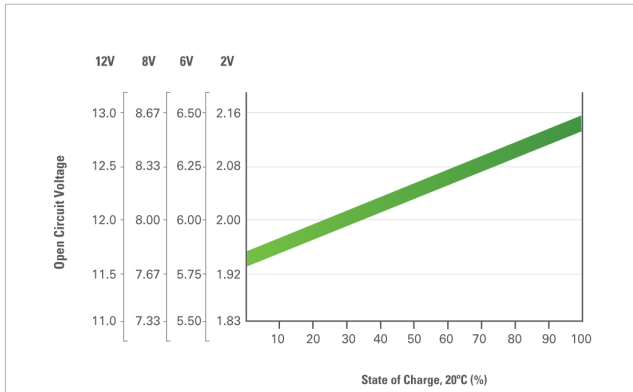

Self-Discharge Characteristics

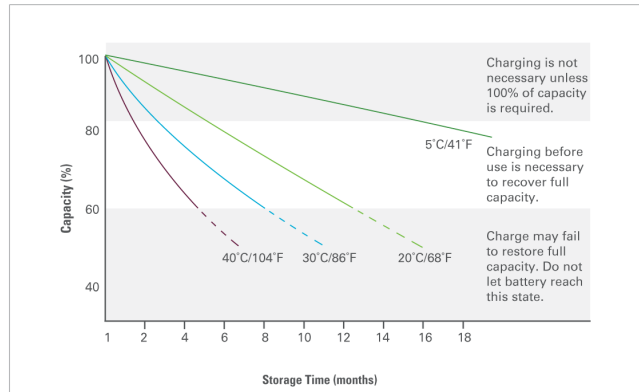

IUI Pulse Charge Profile

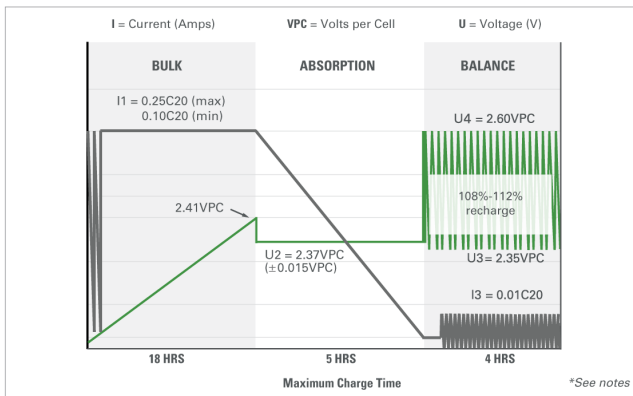

Constant Current (IU) Charge Profile

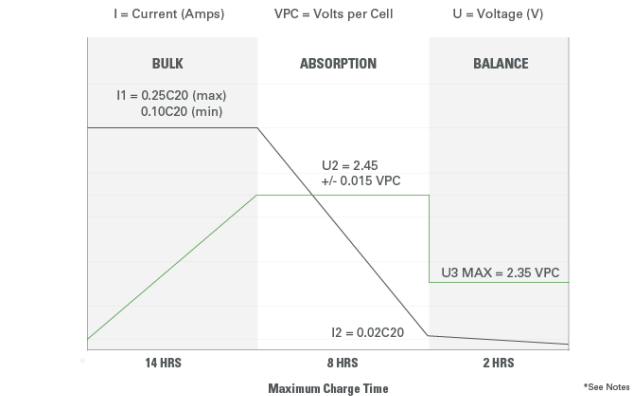

Voltage Regulated (IUU) Charge Profile

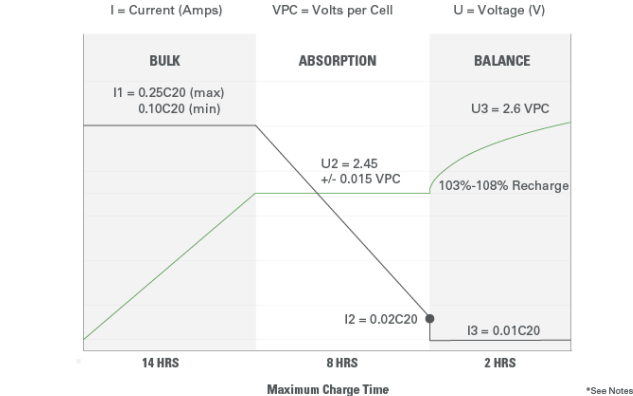

Relations between Charge, Voltage, and Temperature

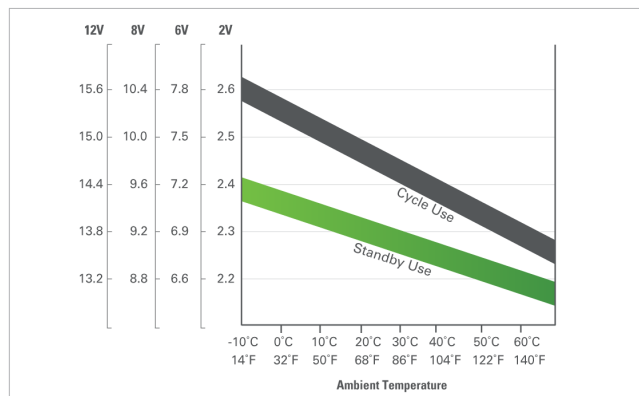

- Due to self-discharge characteristics of lead-acid battery technologies, batteries should be top charged within 6 months of storage to ensure optimum performance, prevent sulphation and permanent capacity loss.
- Charge profile recommendations correspond to battery voltages at 25°C (77°F). For temperatures below, adjust +5mVPC/°C (+3mVPC/°F). Temperatures above, adjust -5mVPC/°C (-3mVPC/°F). Temperature compensated charging helps ensure optimum battery runtime and life performance.
- Charge profile recommendations depend on application and charger. IUI (or IUI with Pulse) is appropriate for applications that require frequent and deep discharges. IUU is appropriate for applications that are on standby and cycled less frequently.
- IUI with Pulse algorithm uses a pulse termination criterion. The finish current is pulsed on and off in order to keep the battery voltage at a minimum while still reaching target overcharge. If average VPC exceeds U4 and the charger output has been on for more than 30 seconds, the output is shut off until VPC falls to U3.
- IUI Charge Profile (if applicable), may have a continuous float phase added (2.27VPC).